



Otium

NATURE IN A POT

- ✔ Made in Belgium
- ✔ For indoor and outdoor use
- ✔ Double walled: the layer of air between the two walls protects the roots of your plant from frost and heat
- ✔ Retains its shape and unbreakable
- ✔ Drainage system for excess water
- ✔ 100% recyclable
- ✔ UV-resistant and colourfast
- ✔ Weight system to stabilize high pots is provided

- WHT** white
- BLA** black
- ANT** anthracite
- BRN** brune
- CAP** cappuccino
- GR** grey
- LG** lime green
- OG** olive green
- RD** red
- ORNG** orange
- LS** light stone
- DS** dark stone



DS Plastics Belgium bvba

Mosten 18
9160 Lokeren
T:+32(09)280.78.80
F:+32(09)280.78.89

www.dsplastics.be
info@otium-design.com
www.otium-design.com



NATURE IN A POT

At Otium we choose for the rotational moulding manufacturing technique, this technique allows us to work with a very durable polyethylene plastic with many advantages. The Polyethylene products are quite light and therefore easy to manipulate but sufficiently strong, even for prolonged outdoor use. Moreover, it is not sensitive to frost or extreme heat and can be 100% recycled. Otium chooses to use quality raw materials to guarantee the color fastness.

Due to the combination of polyethylene and rotational moulding, we can offer a variety of colors. Besides the many colors of the products we often provide different finishing options so the customer can compose something that perfectly fits his or her environment.





OTIUM FLOWERPOTS

8 Lignum

10 Lignum 40

11 Lignum 55

12 Pendulum

14 Pendulum square

15 Pendulum long

16 Amphora's

18 Amphora 45

19 Amphora 75

20 Murus

22 Murus 27

23 Murus 90

24 Quadris

26 Quadris 40

27 Quadris 60

28 Quadris 40 long

30 Cylindrus FP | Basso FP

32 Cylindrus FP

33 Basso FP

34 Olla's

36 Olla 40

37 Olla 70

38 Olla 100

39 Olla 135

42 Citta

44 Citta 110

OTIUM FURNITURE

46 Olla Tables

48 Olla table vinum

49 Olla table herba

50 Cubus

52 Cubus wood

52 Cubus pillow

53 Cubus LED

54 Cylindrus | Basso

56 Cylindrus wood

56 Cylindrus pillow

57 Basso wood

58 **Technical specifications**

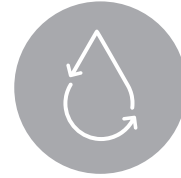

DRAINAGE SYSTEM

Potted plants need to be showcased in flowerpots equipped with a good drainage system in the event of over watering, whether from natural rainfall or over watering by an eager gardener.

Unless excess water can filter through the soil and drain away from the roots of your potted plants, the roots may develop root rot if they are exposed to standing water for an extended period of time. Root rot will eventually cause your potted plant to wither and die since it will rob the plant of the ability to draw moisture and nutrients from the soil.



100% RECYCLABLE

Otium, not only NATURE IN A POT, but also an ecological pot. All Otium pots are made of polyethylene plastic.

Polyethylene is extremely suitable for re-use. It can be melted and re-used indefinitely.



HANGING SYSTEM

FOR PENDULUM

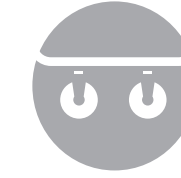
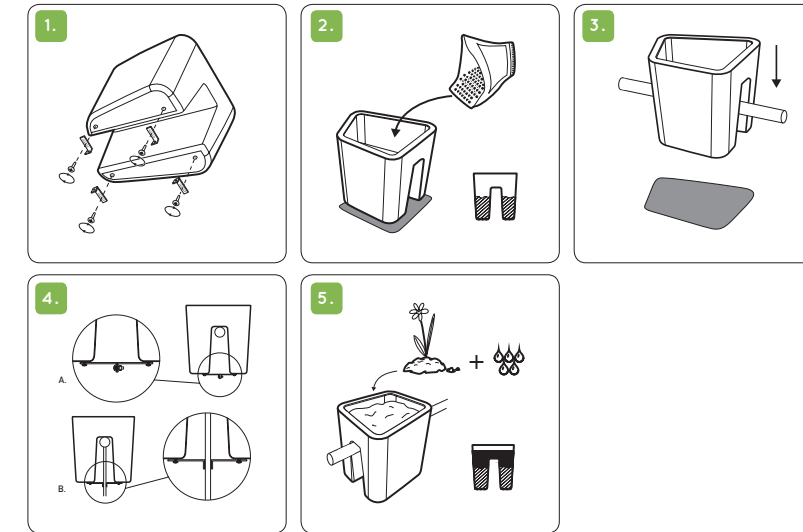

WHEEL SYSTEM

FOR QUADRIS 40 LONG





STACKABLE

FOR LIGNUM & CITTA

The Lignum and Citta flowerpots are stackable to ensure easy transportation.



SINGLE WALL DOUBLE WALL

The air gap between the two walls creates a layer of isolation for the roots of the plant. And protects them from frost and heat.

Double wall pots are protected for heavy sun burn of the outside layer and prevent the roots from burning.



EXTRA WEIGHT SYSTEM

FOR OLLA 135, AMPHORA 75 & MURUS 27-90

Otium Olla135, Amphora 75 and Murus (27&90) are provided with an extra weight system. The system is simply a closable opening. Through the free space between the two walls there is enough space to pour grind or gravel in the pot.

If enough weight is inserted, the pot will have extra stability and will not fall over in strong winds.

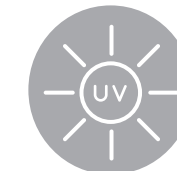

UV-RESISTANT & COLOURFAST

Otium chooses to use quality raw materials to guarantee the color fastness.

1





LIGNUM

lignum 40 . lignum 55



LIGNUM 40



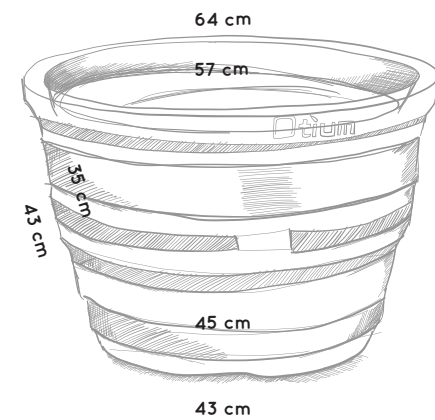

Meet quirky Lignum, instantly striking thanks to the mix of textures. Rough and smooth together, the best of both worlds. At home in both polished and more robust environments, either indoors or out.

	height	top Ø	bottom Ø	volume	 
INSIDE	35 cm	57 cm	45 cm	75 L	 
OUTSIDE	43 cm	64 cm	43 cm		



LIGNUM 55

Both the larger and more compact Lignum have been specially designed with small, cultured trees in mind. That's precisely why they're so stable. Though tall trees often catch the wind, Lignum stands firm.

	height	top Ø	bottom Ø	volume	 
INSIDE	45 cm	73 cm	56 cm	150 L	 
OUTSIDE	55 cm	81 cm	56 cm		

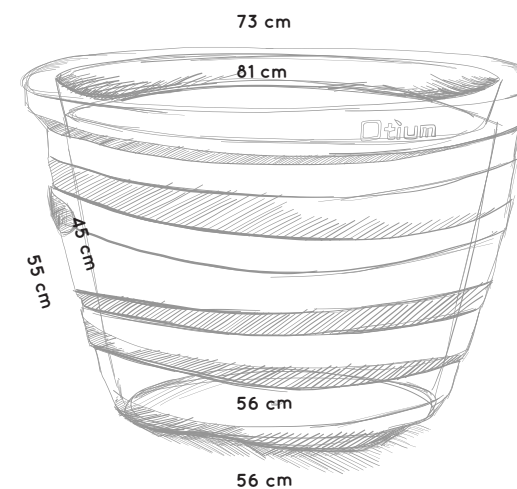

2

*by Maxime Szyf***PENDULUM**

pendulum square . pendulum long

The PENDULUM railing planter is an aesthetic solution for a spatial problem: how can we bring nature close to the limited space of a balcony. We also wanted a solution for creating extra privacy on the terrace.

The PENDULUM railing planter answers to these requirements. Rotational-moulded durable, recyclable and impact resistant polyethylene, we realised an atypical and switchable asymmetrical shape in a generous size for creating a plant landscape. By combining the two dimensions, the flower pots can be placed in a variety of arrangements in order to give the bal-

cony a contemporary and personal finishing. The PENDULUM planters can also be placed on the ground.





We came up with an additional volume as seasoning container for an urban garden environment.

Designed by Maxime Szyf
www.maximaldesign.com - www.yellowwindow.com



PENDULUM SQUARE

Solid, square and robust, but not hard or sharp. Thanks to its rounded corners the Pendulum Square has a soft look. Tough, but still a cookie.

	height	length	width	volume	
INSIDE	39 cm	36 cm	31 cm	44 L	 
OUTSIDE	39 cm	42 cm	37 cm		 

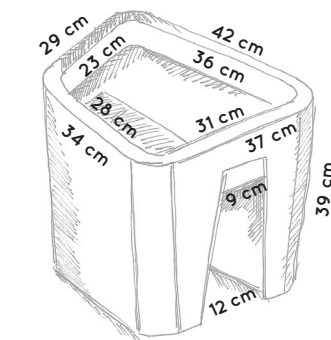





The Otium PENDULUM is a high quality single walled polyethylene railing planter. The planter is provided with a security system to prevent the planter falling of the railing.



PENDULUM LONG

Extended elegance with soft curves. This long brother of the Pendulum Square offers even more green space. Perfectly tailored for those who think that choosing is losing.

	height	length	width	volume	
INSIDE	39 cm	69 cm	33 cm	81 L	 
OUTSIDE	39 cm	75 cm	39 cm		 

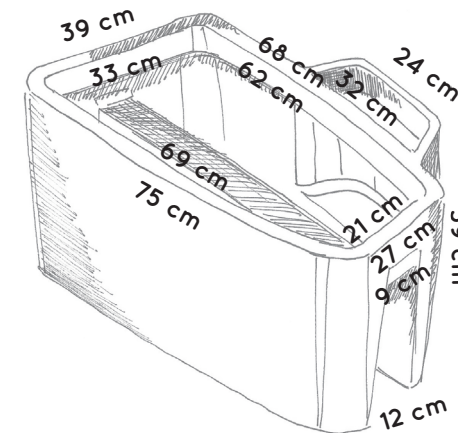

3 AMPHORA'S





amphora 45 . amphora 75

These Otium AMPHORA'S are as elegant as plants reaching for the sun. Available in large or small and as a result the perfect couple. Because sometimes less is not more.



AMPHORA 45



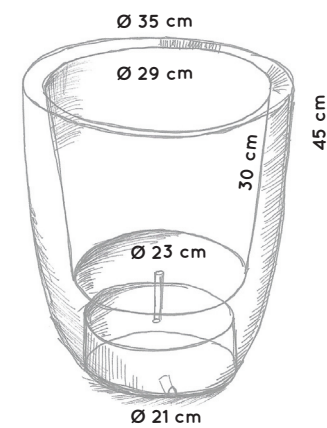

Otium Amphora 45 is a high quality double walled polyethylene planter. Otium drainage system makes sure there is adequate drainage for the plants. When planting inside, the drainage system can be closed by using the supplied screw cap with rubber seal.

	height	top Ø	bottom Ø	volume	 
INSIDE	30 cm	29 cm	23 cm	18 L	 
OUTSIDE	45 cm	35 cm	21 cm		



AMPHORA 75

The Otium Amphora 75 is the bigger brother of the Otium Amphora 45. Both flowerpots look perfectly next to each other. Outdoor and indoor use are possible. It's basic shape, provided with smooth curves makes the Amphora 75 the perfect addition to the Otium Family.

	height	top Ø	bottom Ø	volume	 
INSIDE	30 cm	33 cm	29 cm	24 L	  
OUTSIDE	75 cm	40 cm	27 cm		

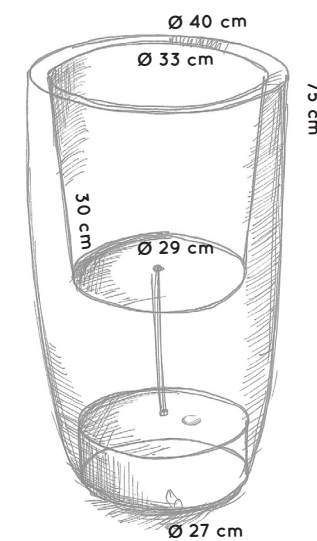

4

MURUS

murus 27 . murus 90





The Otium MURUS is a high quality double walled polyethylene planter. Otium drainage system makes sure there is adequate drainage for the plants. When planting inside, the drainage system can be closed by using the supplied screw cap with rubber seal.

The Murus bottom has an opening for extra weight in order to stabilize the pot. With the supplied screw you shut the back opening. We recommend to use gravel as material for extra weight.



MURUS 27



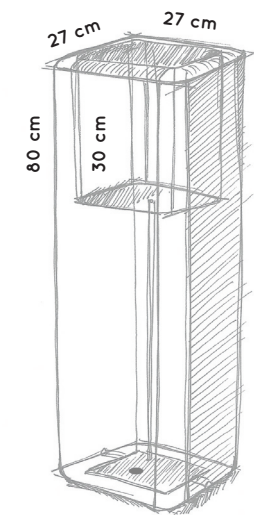

Do you want to discretely brighten up that wall or that corner of the room with a bit more green? Well, Murus 27 is your partner in crime. Can it be more outstanding? Then you might opt for a Murus collection.

	height	length	width	volume	  
INSIDE	30 cm	22 cm	22 cm	17 L	 
OUTSIDE	80 cm	27 cm	27 cm		



MURUS 90

Wide enough to build your own mini-jungle. Indeed, when you choose high plants, the Murus 90 makes the perfect stylish partition.

	height	length	width	volume	 
INSIDE	30 cm	84 cm	22 cm	66 L	  
OUTSIDE	80 cm	90 cm	27 cm		

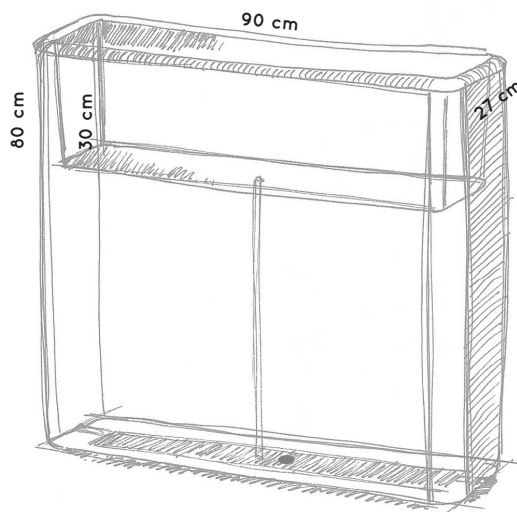

5

QUADRIS

quadris 40 . quadris 40 long . quadris 60

The Otium QUADRIS is a high quality double walled polyethylene planter. Otium drainage system makes sure there is adequate drainage for the plants. When planting inside, the drainage system can be closed by using the supplied screw cap with rubber seal.



QUADRIS 40

Design is in the detail. So this basic mould has rounded corners, as organic as the flowers and plants which it discretely puts in the spotlight. Inside as well as outside.

	height	length	width	volume	 
INSIDE	34 cm	36 cm	36 cm	43 L	 
OUTSIDE	44 cm	44 cm	44 cm		

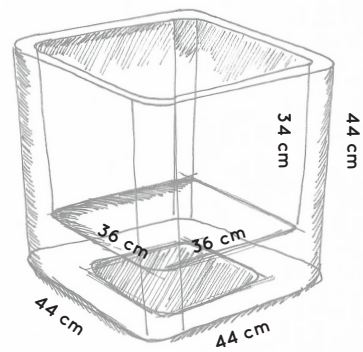

QUADRIS 60



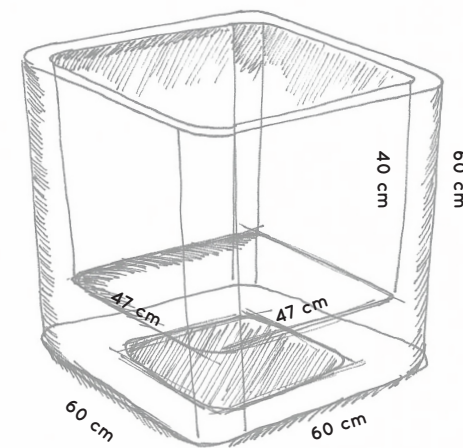

Just a bit bigger, just a bit more imposing, so there's more space for more flowers. The Quadris 60 brings more green inside and also steals the show outside, in the garden or on the terrace.

	height	length	width	volume	 
INSIDE	40 cm	47 cm	47 cm	95 L	 
OUTSIDE	60 cm	60 cm	60 cm		



QUADRIS 40 LONG

When you like to play with volume and shape, this Quadris is a perfect addition to your collection. It can be combined with other Quadris family members as well as with the rest of the Otium family. And yes, when throwing a party you can even use it as a bucket for bottles.

	height	length	width	volume	  
INSIDE	34 cm	81 cm	36 cm	106 L	 
OUTSIDE	44 cm	90 cm	44 cm		

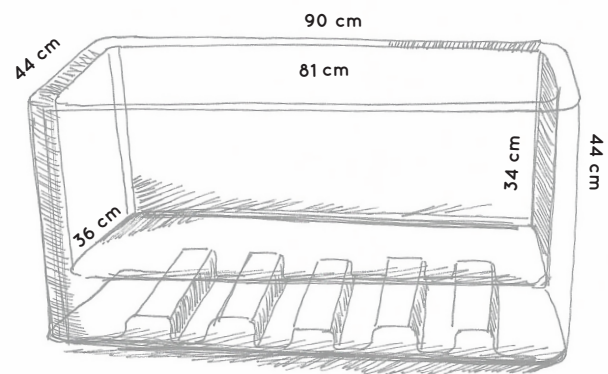

6

CYLINDRUS FP | BASSO FP

The Otium CYLINDRUS FP is a double walled flowerpot with a drainage system. With its sober design it fits into almost any environment. Use Cylindrus with a seating cushion and without as flowerpot, very nice combinations can be made.





The Otium BASSO FP is a high quality double walled polyethylene planter. Otium drainage system makes sure there is adequate drainage for the plants. When planting inside, the drainage system can be closed by using the supplied screw cap with rubber seal.





CYLINDRUS FP

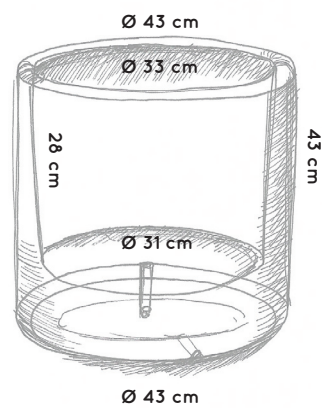

Simplicity is a virtue. Just like how an exceptionally beautiful flowerpot can remain discretely in the background. It's a matter of not outdoing natural beauty, but of highlighting it.

	height	top Ø	bottom Ø	volume	 
INSIDE	28 cm	33 cm	31 cm	26 L	 
OUTSIDE	43 cm	43 cm	43 cm		



BASSO FP

Just a touch larger and therefore suitable for low as well as high bloomers. Whatever you plant, the Basso FP emphasizes each flower or plant even more.

	height	top Ø	bottom Ø	volume	 
INSIDE	25 cm	69 cm	61 cm	90 L	 
OUTSIDE	43 cm	80 cm	67 cm		

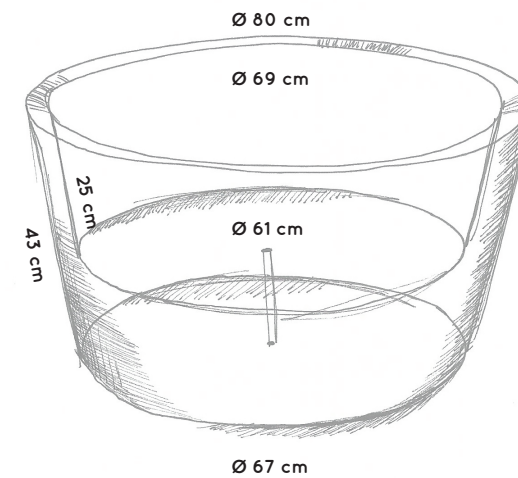

7

OLLA'S





olla 40 . olla 70 . olla 100 . olla 135

Otium OLLA'S are high quality double walled polyethylene planters. Otium drainage system makes sure there is adequate drainage for the plants. When planting inside, the drainage system can be closed by using the supplied screw cap with rubber seal.



OLLA 40



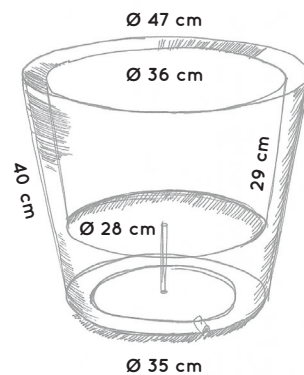

The smallest one in the Otium family. The OLLA 40 is a standalone hit, but even more impressive in a group. Are you going for a tone-on-tone ensemble or do you want to give your plant corner even more colour?

	height	top Ø	bottom Ø	volume	 
INSIDE	29 cm	36 cm	28 cm	24 L	 
OUTSIDE	40 cm	47 cm	35 cm		



OLLA 70



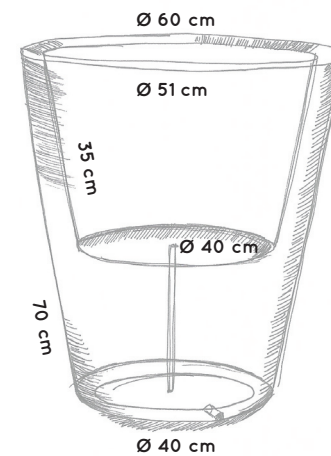

The OLLA branch of the family offers endless choices. The OLLA 70 is the slightly longer version, making it the perfect companion. Because every little sister needs a big brother.

	height	top Ø	bottom Ø	volume	 
INSIDE	35 cm	51 cm	40 cm	60 L	 
OUTSIDE	70 cm	60 cm	40 cm		



OLLA 100



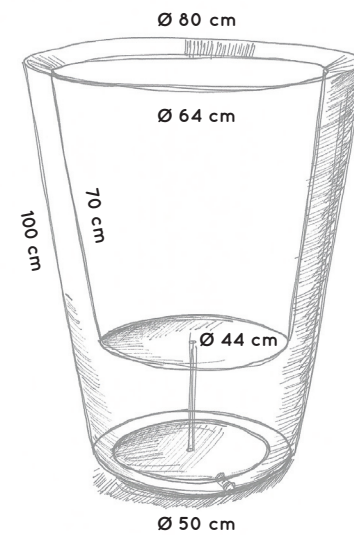

The higher the pot, the wider it is. Plants that love a little space feel great in the metre-high OLLA. The OLLA 100 is the perfect eyecatcher.

	height	top Ø	bottom Ø	volume	 
INSIDE	70 cm	64 cm	44 cm	163 L	 
OUTSIDE	100 cm	80 cm	50 cm		



OLLA 135

A pot that makes a statement - that's the OLLA 135 in a nutshell. A clear, powerful design and a size that cannot be hidden. And why should you? Due to its slim shape the Olla 135 is the ideal planter for the decoration of a hall or a doorway.

	height	top Ø	bottom Ø	volume	 
INSIDE	36 cm	44 cm	32 cm	46 L	  
OUTSIDE	135 cm	54 cm	37 cm		

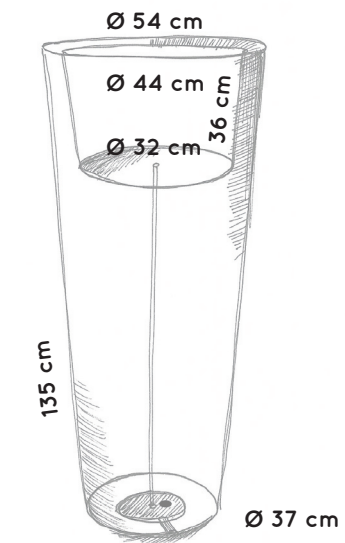

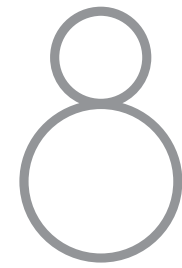

CITTA

citta 110

Large, larger, largest. Let there be no mistake, CITTA is the largest and most impressive specimen in the Otium range.



CITTA

Citta is a pot that makes its presence known and cannot be ignored. The design effortlessly brightens up cities, parks, amusement parks and allotments.

	height	top Ø	bottom Ø	volume	
INSIDE	110 cm	105 cm	75 cm	690 L	
OUTSIDE	110 cm	120 cm	75 cm		

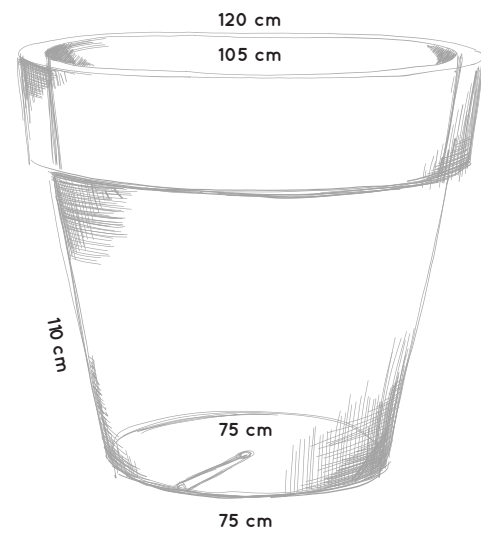

9



OLLA TABLE

olla table vinum . olla table herba



OLLA TABLE VINUM

A flower pot with a table character or is it the other way around. Meet the Olla Table Vinum. It can be used to lean on during extensive receptions. The heart of the table can easily be filled with ice and keeps a nice stock of champagne nicely chilled. Toast in style.

	height	top Ø	bottom Ø	volume	 
OUTSIDE	110 cm	131 cm	50 cm	24 L	 

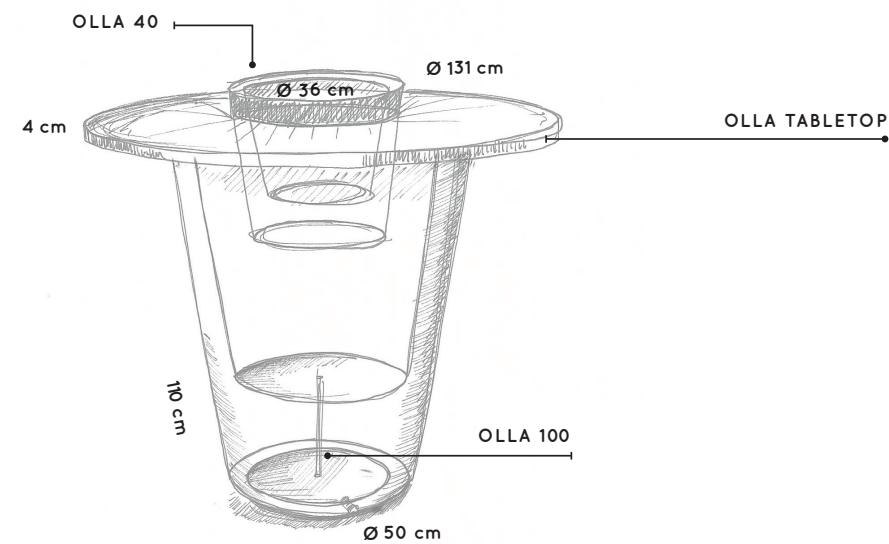

The Otium OLLA TABLE VINUM is an assembly of the Olla 100, Olla 40 and a table top in teak. Personalize your Olla table vinum by making your own color combinations!



OLLA TABLE HERBA

Are you more into plants than into champagne? Then you can opt for the Olla Table Herba and fill the special pot with your favourite plants. The broad wooden edge puts them even more in the spotlight and gives you support while you maintain the plants.

	height	top Ø	bottom Ø	volume	 
OUTSIDE	102 cm	131 cm	50 cm	163 L	 

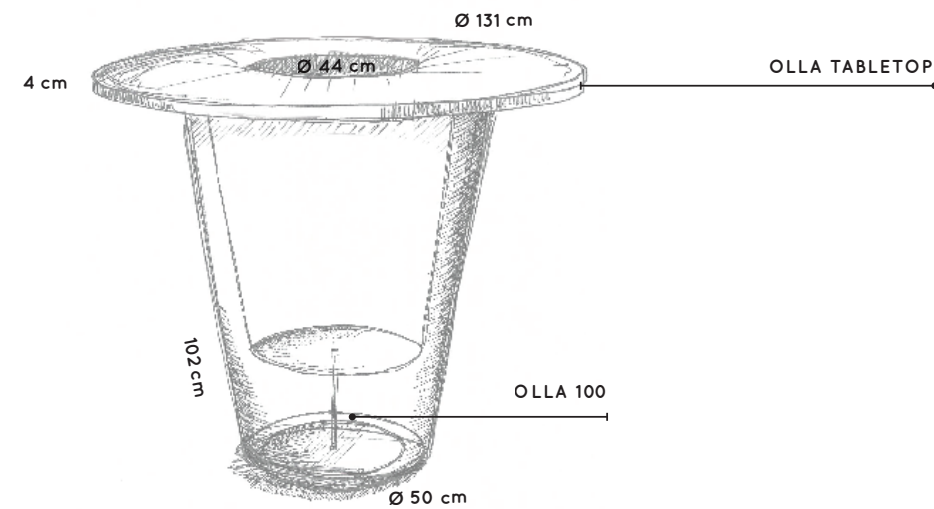

The Otium OLLA TABLE HERBA is an assembly of the Olla 100 and a table top in teak.



10 CUBUS

cubus wood . cubus pillow . cubus led

The Otium CUBUS can be obtained with a pillow and a wooden plank lining. Besides the 12 colors of cube itself there are four types of pillows available black, white, red and a pillow with two colors black & white.



CUBUS

cubus wood . cubus pillow

Do you like taking your time to admire all that splendour of plants and garden beauty? Meet the Cubus. A seat that not only fits perfectly with your collection of pots, it also comes in a wooden or soft finish.

OUTSIDE	height	length	width	 
	43 cm	43 cm	43 cm	

FINISH     

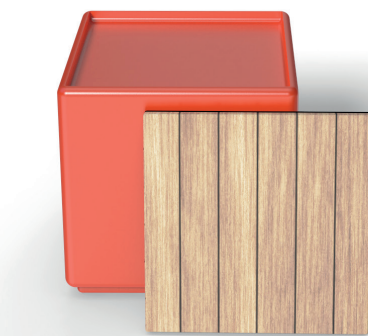
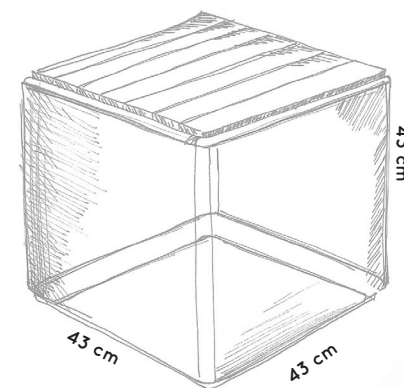

WOOD



PILLOW



CUBUS LED

Need light? This Cubus makes it comfortable and lightens its surroundings at the same time. A real focus-puller!

OUTSIDE	height	length	width	 
	43 cm	43 cm	43 cm	

FINISH     



Light: RGB LED
Voltage: 110v - 240v , DC: 5v
Colors: 16 Color Change
Waterproof: IP 54
Has Passed: CE,UL,ROHS
12 hours charge for first use.

The Otium Cubus LED contains different colors you can easily change with the remote controler. Moreover you can have different running programs to set the color to change automatically.



11

CYLINDRUS | BASSO

cylindrus wood. cylindrus pillow | basso wood

The Otium CYLINDRUS has besides its cool looks a very practical aspect with its storage space. Furthermore he has 12 basic colors and a wooden or soft finish.





The Otium BASSO is the ideal complement to Otium Cubus and Cylindrus. This low table with storage or footstool with storage comes in handy everywhere.



CYLINDRUS

cylindrus wood. cylindrus pillow

Can it be a bit softer, a bit rounder, a bit more feminine? The Cilindrus is the Cubus's proud sister. Same principle, but a softer design.

	height	top Ø	bottom Ø	volume	 
INSIDE	28 cm	33 cm	31 cm	26 L	 
OUTSIDE	43 cm	43 cm	43 cm		

FINISH    

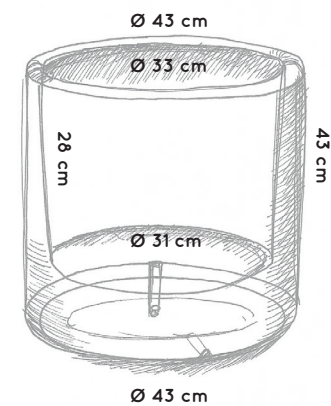

WOOD







PILLOW



BASSO

With each seat goes a table. Basso takes up that function splendidly. So, no more glasses on the floor, which you knock over as soon as you move a foot. As of now, you meet around the Basso.

	height	top Ø	bottom Ø	volume	 
INSIDE	25 cm	69 cm	61 cm	90 L	 
OUTSIDE	43 cm	80 cm	67 cm		

FINISH 

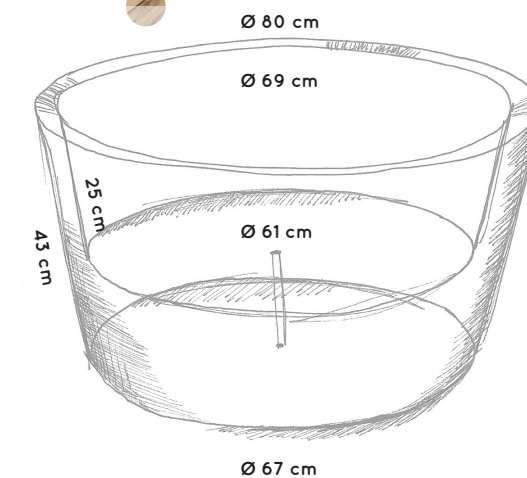













TECHNICAL INFO

FLOWERPOTS











P.	NAME	INSIDE MEASURE (cm)					OUTSIDE MEASURE (cm)			
		HEIGHT	TOP DIAMETER	BOTTOM DIAMETER	LENGTH & WIDTH	VOLUME (L)	HEIGHT	TOP DIAMETER	BOTTOM DIAMETER	LENGTH & WIDTH
12	LIGNUM 40	35	57	45	x	75	43	64	43	x
13	LIGNUM 55	45	73	56	x	150	55	81	56	x
16	PENDULUM SQUARE	39	x	x	36 X 31	44	39	x	x	42 X 37
17	PENDULUM LONG	39	x	x	69 X 33	81	39	x	x	75 X 39
20	AMPHORA 45	30	29	23	x	18	45	35	21	x
21	AMPHORA 75	30	33	29	x	24	75	40	27	x
24	MURUS 27	30	x	x	22 x 22	17	80	x	x	27 x 27
25	MURUS 90	30	x	x	84 x 22	66	80	x	x	90 x 27
28	QUADRIS 40	34	x	x	36 x 36	43	44	x	x	44 x 44
29	QUADRIS 60	40	x	x	47 x 47	95	60	x	x	60 x 60
30	QUADRIS 40 LONG	34	x	x	81 x 36	106	44	x	x	90 x 44
34	CYLINDRUS FP	28	33	31	x	26	43	43	43	x
35	BASSO FP	25	69	61	x	90	43	80	67	x
38	OLLA 40	29	36	28	x	24	40	47	35	x
39	OLLA 70	35	51	40	x	60	70	60	40	x
40	OLLA 100	70	64	44	x	163	100	80	50	x
41	OLLA 135	36	44	31	x	46	135	54	37	x
44	CITTA 110	110	105	75	x	690	110	120	75	x

-  WHT
-  BLA
-  ANT
-  BRN
-  CAP
-  GR
-  LG
-  OG
-  RD
-  ORNG
-  LS
-  DS

FURNITURE

P.	NAME	HEIGHT	TOP DIAMETER	BOTTOM DIAMETER	LENGTH & WIDTH	FINISHING
48	OLLA TABLE VINUM	110	131	50	-	
49	OLLA TABLE HERBA	102	131	50	-	
52	CUBUS	43	-	-	43 X 43	    
56	CYLINDRUS	43	43	43	-	   
57	BASSO	43	80	67	-	

FINISHING

P.	NAME	DIAMETER	LENGTH & WIDTH	FINISHING
48	OLLA TABLE TABLETOP	131	-	
52	WOOD CUBUS	-	40 x 40	
52	PILLOW CUBUS	-	40 x 40	   
56	WOOD CYLINDRUS	37	-	
56	PILLOW CYLINDRUS	37	-	  
57	WOOD BASSO	74	-	





COMPOSITIONS

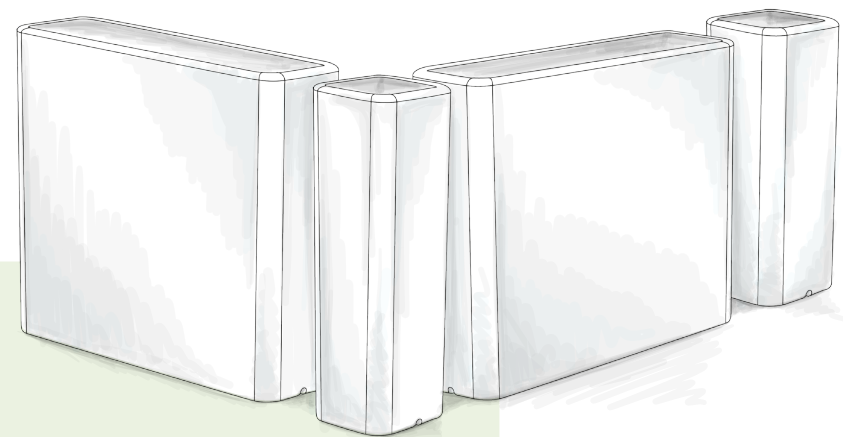

2 x murus 27
2 x murus 90

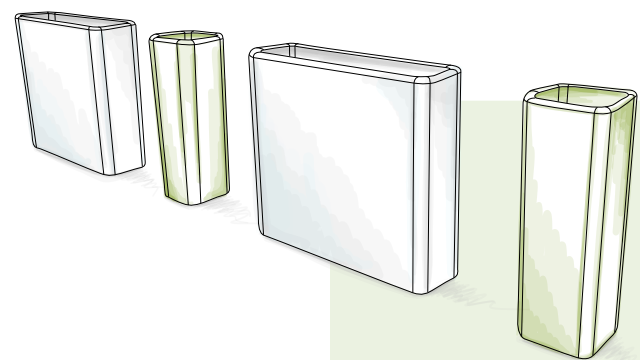

2 x murus 27
2 x murus 90

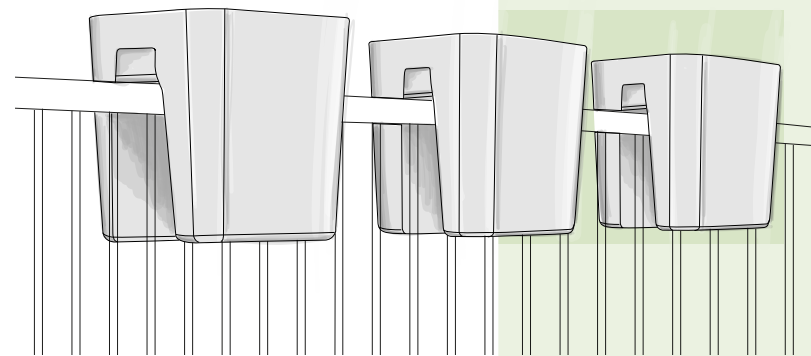

3 x pendulum square

2 x pendulum square
1 x pendulum long

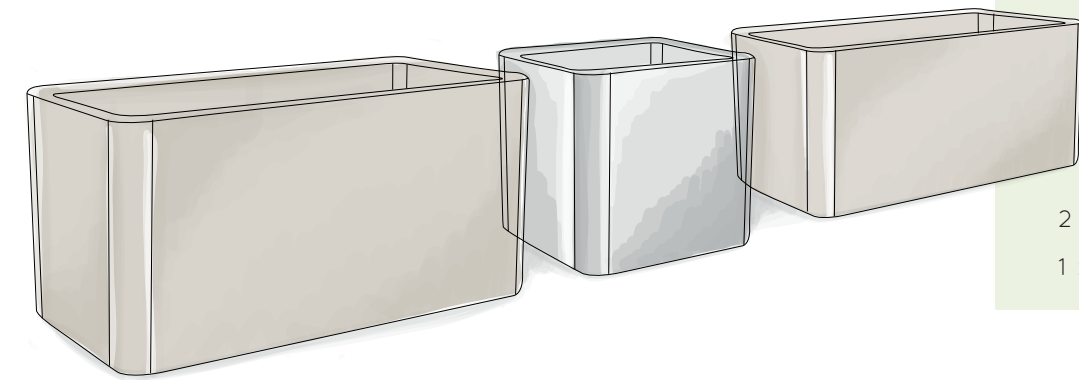
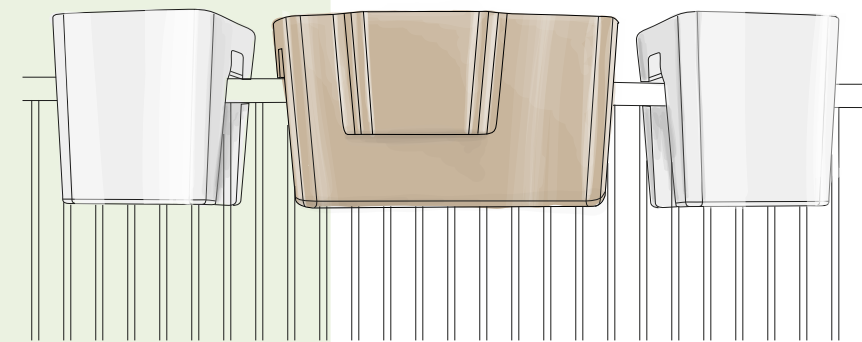

2 x quadris long
1 x quadris 40

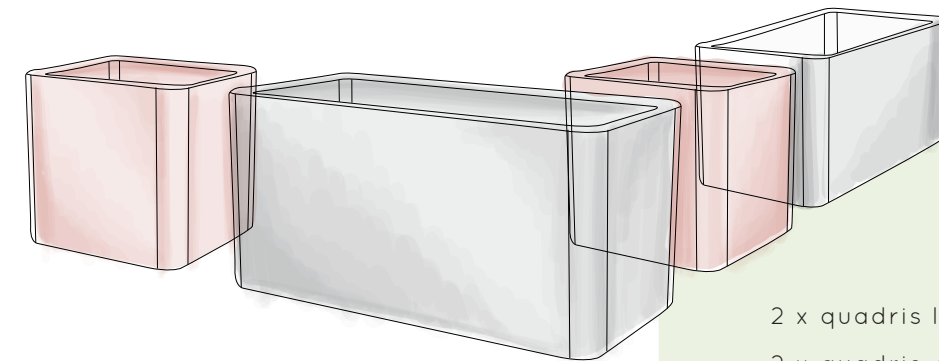

2 x quadris long
2 x quadris 40

Otium
NATURE IN A POT